

DCX Data Logger Operating Instructions

Version 1.04 - November 2004

General information

Fluid levels or fluctuations of a liquid can be determined by measuring the prevailing pressure at a lower depth and comparing it with the pressure at the surface. This enables an approximate calculation based on the density of the liquid. For example, in the case of water: $100\text{mbar} \approx 100\text{cm}$ water column (WC).

Measuring is always realized in relation to the ambient pressure (the pressure on the surface) in the case of open systems or classical filling level measurement. This is achieved in conventional water level sensors through a reference tube integrated in the sensor cable which determines the relationship to the ambient pressure. Measurement of air pressure fluctuations is thus independent. An alternative option exists in intelligent systems, involving the realization of an absolute pressure measurement and calculation of the air pressure correction using an additional barometer. This means that the special cable (with the reference tube) need not be utilized.

KELLER provides a variety of data loggers, depending on the measuring method employed.

Measuring methods

Relative measurement (DCX-22 VG)

The DCX-22 VG is based on the classical level measuring method. The instrument is equipped with a relative pressure sensor. The air pressure is conveyed through the reference tube integrated in the sensor cable at the rear of the sensor. The cable should therefore not be bent or crushed! The upper end of the reference tube is fitted with a GORE-TEX® membrane. This prevents dirt or liquid entering the instrument, while still ensuring the air exchange.

DCX-22 VG



Absolute measurement (DCX-22 / DCX-22 SG / DCX-22 AA)

The DCX-22 and DCX-22 SG instruments utilize an absolute pressure sensor. A second DCX-22 is positioned on the surface as a barometer where low water depths are involved (as the influence of air pressure fluctuations must also be taken into consideration), and the air pressure characteristic is recorded. The water level is then calculated in the PC program (Logger 4.x) as the difference between the two measured values.

DCX-22**DCX-22 SG**

The DCX-22 should be pulled out of the measuring position to read out the data. The interface connector is located in the instrument itself. The DCX-22 can be utilized with extreme flexibility, due to the fact that it has no cable.

In contrast to the DCX-22, the DCX-22 SG is fitted with a cable with a read-out connector on its end. It is therefore possible to read out the DCX-22 SG without removing it from the measuring position.

The DCX-22 AA has a second absolute pressure sensor integrated in the read-out unit (which acts as a barometer) and automatically calculates the difference between the two measuring values. This enables a direct read-out of the water level. The advantage of this solution when compared with the DCX-22 VG (which utilizes a reference tube for air pressure compensation) is that the entire system is hermetically sealed against exterior influences. The disadvantage is that the resolution is slightly less than that of the DCX-22 VG.

The maximum measuring range is limited to 10mWC, due to signal loss in the cable between the sensor and read-out unit.

DCX-22 AA

Installation

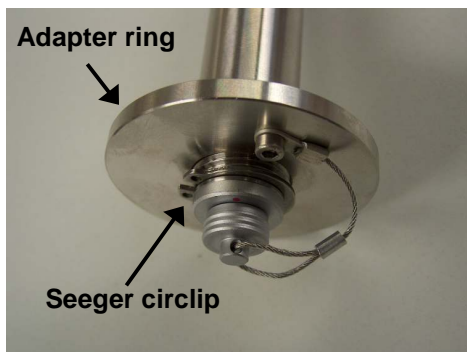
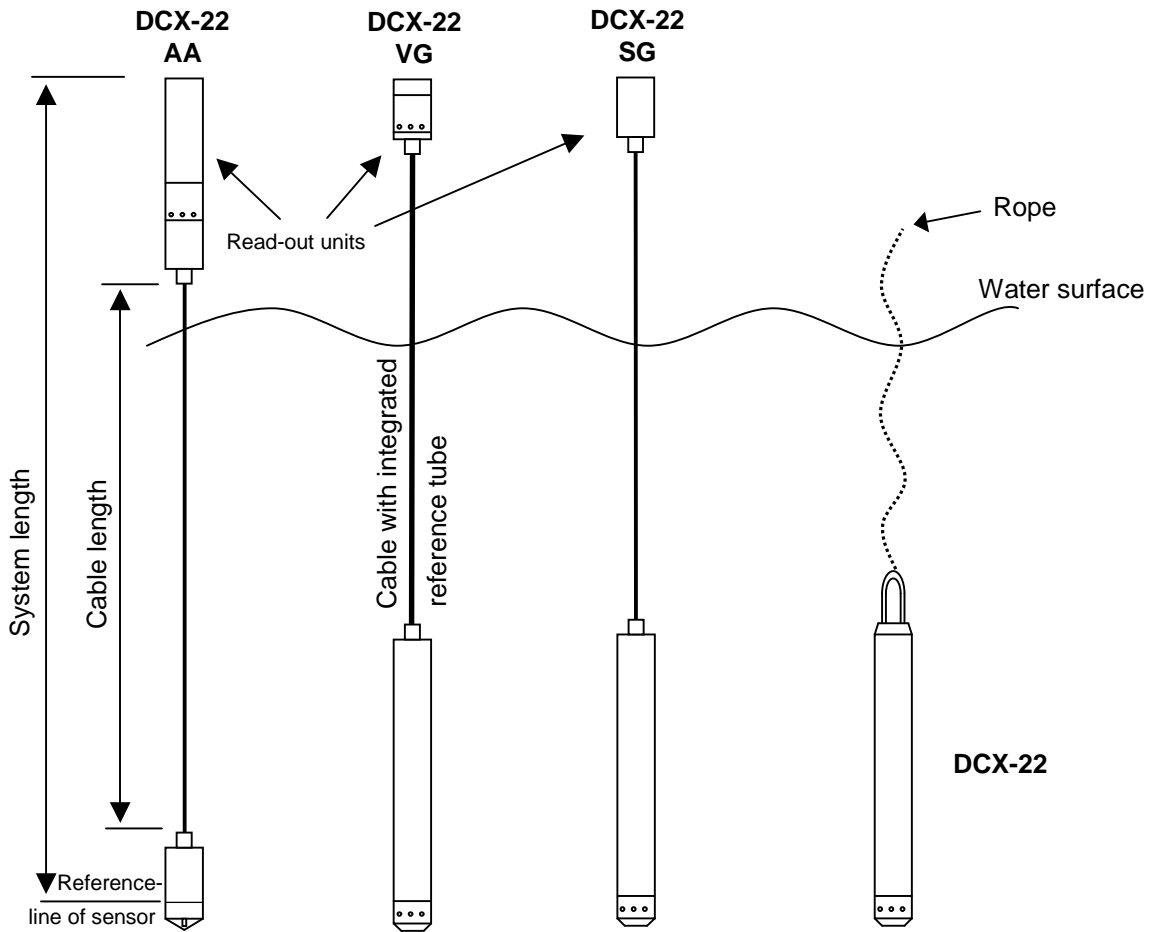

The data loggers are lowered into the sinking pipe and fixed in position with an adapter ring (see accessories). The respective adapter ring is screwed onto the DCX and secured with the Seeger circlip ring supplied (see accessories).

It should be noted that the cable length selected initially for the DCX-22 AA / SG / VG is a fixed dimension and cannot be changed. The desired cable length should therefore be specified when ordering.

Application example (DCX-22 AA installation)



The sinking pipe is secured firmly at the measuring location. Openings should be provided above ground level if the sinking pipe is buried in the ground. These ensure that water can enter.



The sensor is lowered into the sinking pipe. It is connected by the cable to the housing. The housing contains the electronics, the battery and the air pressure sensor.



The adapter ring is screwed onto the electronics housing and rests on the edge of the sinking pipe.



The system can be connected on site to a laptop using a data cable. The stored measuring values can now be read out, or the instrument can be reconfigured.

DCX configuration/read-out

A converter is required to establish a connection between the instrument and the PC for configuring or reading out the DCX. The K-103A interface converter is utilized to establish a connection to the serial interface (RS 232). However, a K-104A converter is required if the logger is to be connected to a USB interface (see accessories). The USB driver supplied with the instrument should be installed when using this converter.

One end of the cable fitted to the converter is then plugged into the DCX, the other end is connected to the PC.

The Logger 4.x software can now be started on the computer.

Caution:

The DCX must not be disconnected from the interface during communication (writing, reading out, online function). The program must always be terminated before unplugging the instrument.

Replacing the battery

Battery: Sonnenschein 3.6V lithium AA type: SL-760 (see accessories)

The DCX should be dried prior to opening to prevent water entering the instrument during opening. The data logger should only be opened or closed in dry ambient air!

DCX-22 AA / VG / SG

The battery is replaced by first removing the knurled nut, followed by the battery sleeve:

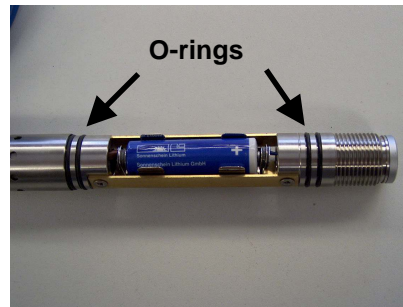
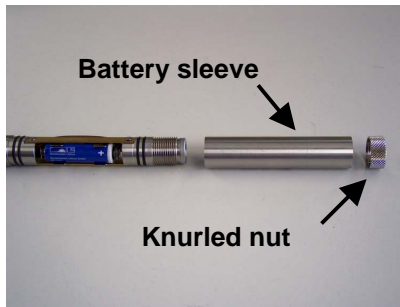

DCX-22

The bracket and knurled nut should be unscrewed first in the case of the DCX-22. The battery sleeve can then be removed:

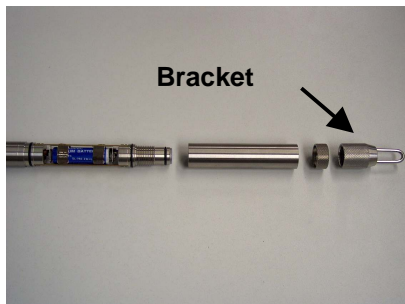

Note:

It is recommended that the battery be first shorted (for approx. a half a second) prior to insertion. This is necessary because the voltage is no longer at nominal level after a longer period of storage. The battery is effectively "reactivated" by shorting it.

Please note the correct polarity when inserting the new battery (see symbol on battery bracket). This opportunity should also be used to check the black O-rings which seal the battery chamber. The ring seals must be replaced if they show evidence of damage ($\varnothing 17 \times 1.5$: see accessories). It is also important to ensure that the O-rings are not damaged when remounting the sleeve.



The battery capacity indicator is automatically set to 99% again each time a battery is replaced (voltage interruption). This also occurs if the same battery or a discharged battery is inserted. The battery should for this reason only be replaced when it has been ascertained that it is truly flat.



Care

Caution:

**The pressure sensor membrane is extremely delicate.
The membrane must therefore never be touched!!**



It is recommended that the pressure sensor be cleaned carefully from time to time if the data logger is being used in extremely dirty or contaminated media:

DCX-22 AA: battery housing

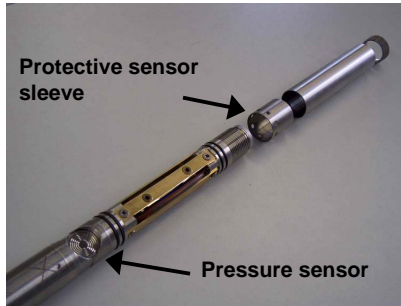

The knurled nut, battery sleeve and protective sensor sleeve should be removed if the pressure sensor is to be cleaned effectively (see illustration on left). Please ensure that the delicate membrane is not damaged. Rinse the sensor off with clean water. It is imperative that water be prevented from penetrating through to the battery chamber during this operation. This can be prevented by simply

mounting the battery sleeve during cleaning (see illustration on right).



Ensure that all components are dry before mounting the sleeves. The battery should only be replaced in dry ambient air.

The protective sensor sleeve is then mounted (with the holes facing downwards). This is followed by the battery sleeve, which can only be mounted in one direction. It must also be ensured during assembly that the O-rings are not damaged, as it is then imperative that these be replaced (Ø17 x 1.5). The knurled nut is subsequently screwed into position.

DCX-22 AA: lower pressure sensor

The protective cap cannot be removed. Simply rinse the sensor off under flowing water.

WARNING!
Do not attempt to remove the protective cap with a sharp object, as this can destroy the pressure sensor!!



DCX-22 / DCX-22 SG / DCX-22 VG

The black cover is pulled off to clean the pressure sensor. The sensor can then be rinsed off with water.

Under no circumstances must pressure be applied to the delicate pressure sensor membrane, as this can destroy this element!!



Accessories

Description	Scope of delivery	Illustration	Product No.
Closure cap for connection socket with hexagonal socket screw (INOX M3x6) for fixing	Included in delivery		506815.0010
Seeger circlip ring DIN: 471 (BN: 682) Ø=18	Included in delivery		508830.0002
Battery suitable for: - DCX-22 - DCX-22 SG / VG / AA Brand: Sonnenschein, Lithium 3.6V AA type: SL-760	Included in delivery		557005.0010
K-103A interface converter For communication between the PC and the DCX. Connection to serial interface (RS 232 – RS 485 converter)	Optional		309010.0002
K-104A interface converter For communication between the PC and the DCX. Connection to USB interface (USB – RS 485 converter)	Optional		309010.0009
CD software: Logger 4.X Contains programs for DCX configuration and read-out. The software can also be downloaded free of charge in the internet! → www.keller-druck.com (under "Products"- "Pressure Transmitters" → "Autonomous Data Collectors")	Optional		239005.0003
2" sinking pipe closure	Optional		506815.0009
O-ring Ø17x1.5	Spare part		508610.0024

Adapter rings for use with sinking pipe (optionally available)

Suitable for:

- DCX-22 SG
- DCX-22 VG
- DCX-22 AA (round version)

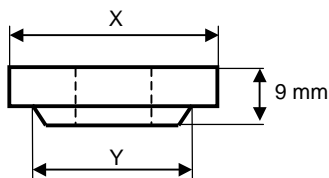

Dimensions [mm]		Drawing No.	Product No.
X	Y		
30	25	33386 item 1	506810.0006
40	25	33386 item 2	506810.0018
49	39	33386 item 3	506810.0015
55	50	33386 item 4	506810.0019
60	55	33386 item 5	506810.0014
65	55	33386 item 6	506810.0020
35	32	33386 item 8	506810.0022
37	32	33386 item 9	506810.0025
42	32	33386 item 10	506810.0026
76	32	33386 item 11	506810.0027
125	32	33386 item 12	506810.0030

Adapter ring for 2" sinking pipe closure with opening for sounder

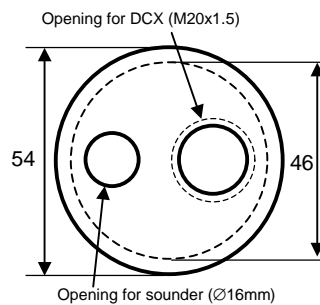

Drawing No.	Product No.
33386-70	506810.0021